

## PRESS-FIT TECHNOLOGY

Authors: Joakim Mattsson, Thorsten Callies, Bart Kerckhof

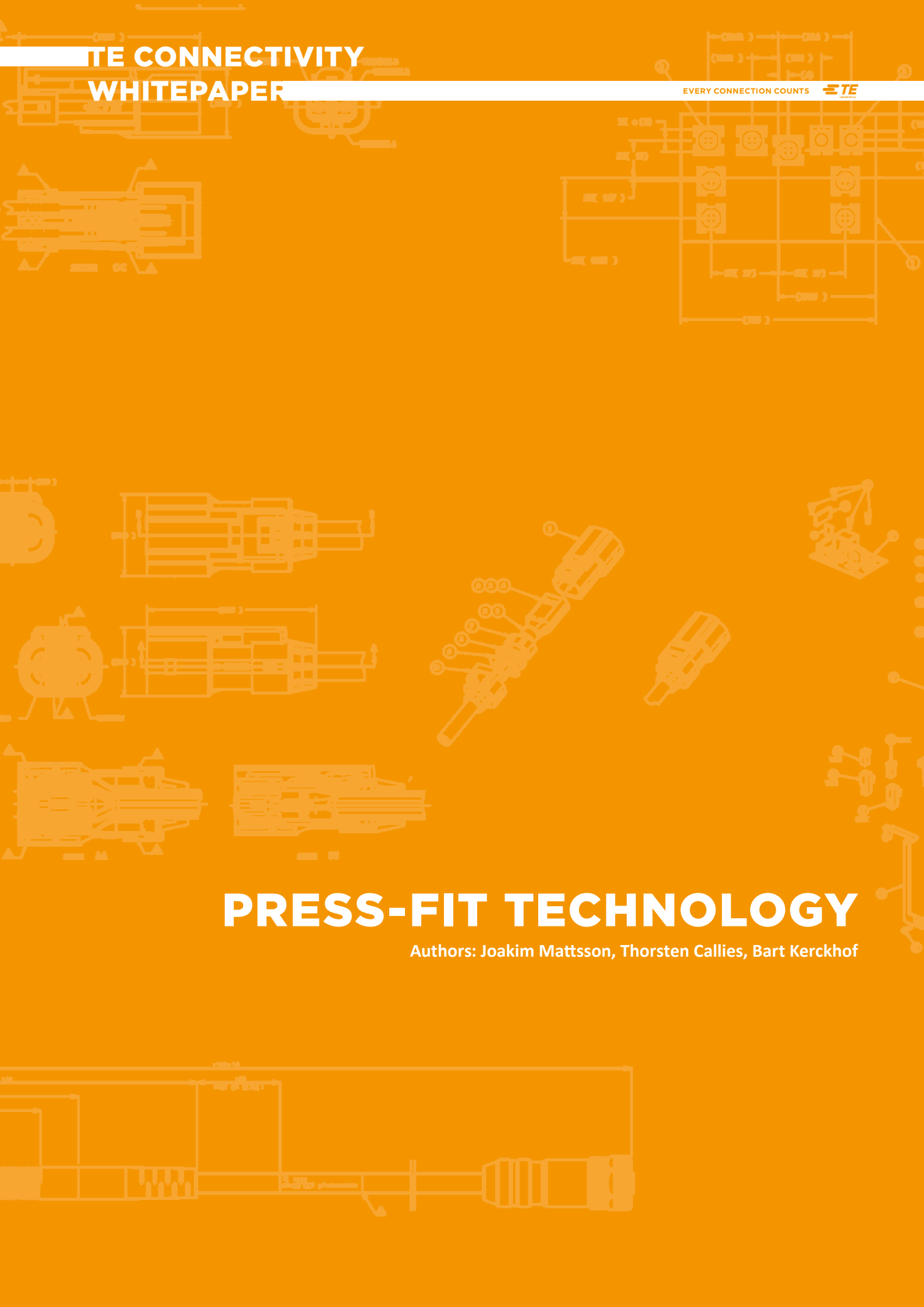

## PRESS-FIT TECHNOLOGY

Authors: Joakim Mattsson, Thorsten Callies, Bart Kerckhof

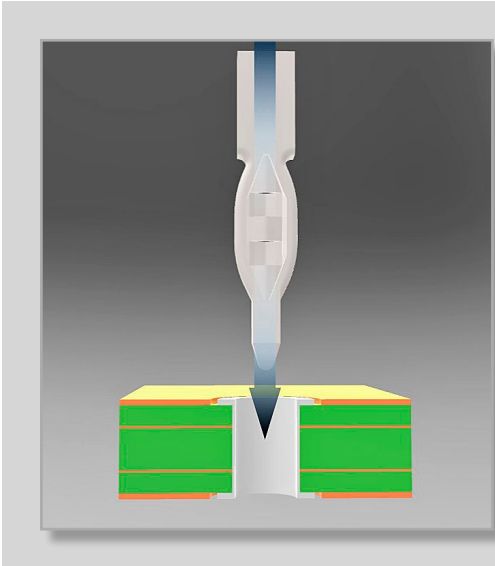

### Abstract

Intention of this whitepaper is to give a brief summary of the press-fit technology at TE Connectivity since this is a major termination technique that is still gaining importance as it is applied in more and more products. The press-fit technology is a solder-less termination technology used in electrical systems throughout the interconnection industry, which mechanically and electrically joins a press-fit contact to a printed circuit board (PCB).

### Table of Contents

1	Introduction	2
2	Overview press-fit solutions	3
3	Market trends	4
4	Materials	5
5	Comparison press-fit vs soldering	6
6	Benefits with press-fit	7
7	Product characteristics and qualification	8
8	Application overview	9
9	Application tooling	11
10	Future / New developments	13
11	Legal Details	14

## 1 | Introduction

This document is an introduction to the Press-fit technology.

The principle for a press-fit connection is that a contact terminal is pressed into a printed circuit board (PCB). There are two types of press-fit pins; the solid pin having a solid press-in zone and the compliant pin having an elastic press-in zone. In this whitepaper only the press-fit pin having an elastic press-in zone is described and it is called the press-fit pin. Press-fit technology from TE Connectivity (TE) was first introduced in the telecommunication industry in the 1970s. Later, in 1988, the first press-fit pin from TE Connectivity was introduced in the automotive industry. Today TE Connectivity offers two distinctive press-fit solutions for automotive applications: ACTION PIN and Multispring pin (see Picture 1) which are both compliant pin designs featuring an elastic behavior during the pin insertion.

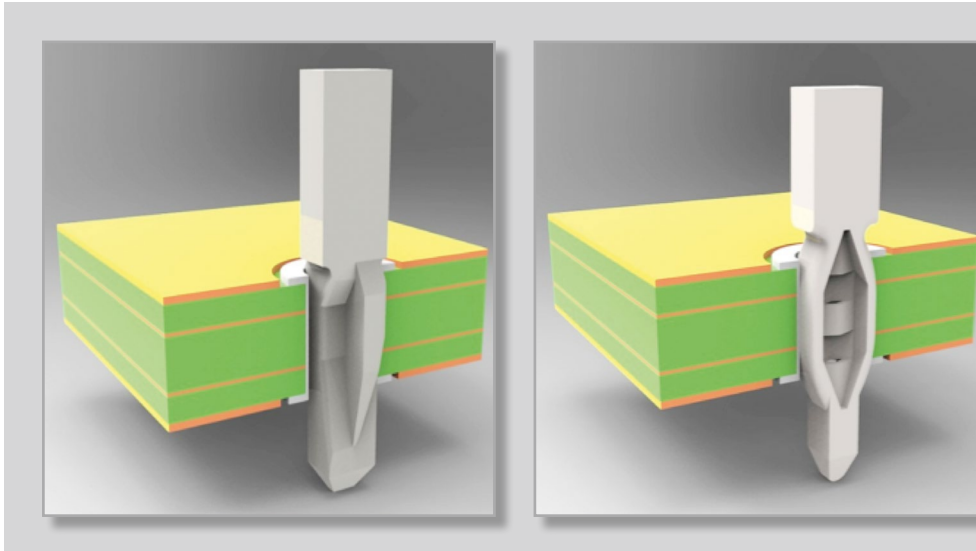

*Picture 1  
The pictures show an  
ACTION PIN press-fit pin (left)  
and a Multispring press-fit pin  
(right).*

In the following chapters several different press-fit aspects will be described and discussed in terms of functionality, properties, characteristics and applications focused on the automotive industry.

TE's press-fit solutions in fact are compliant pins featuring an elastic behavior and thus will deform during insertion (significantly reducing stress on the PCB holes compared to solid press-fit pin – which do no more exist in automotive applications) and sustain a permanent contact normal force when inserted to enable a reliable electrical and mechanical connection over lifetime.

Additionally, high contact normal forces between compliant pin and plated through hole (commonly) generate cold welded interconnections autonomously after the pin insertion; especially, if tin plating is used for at least one of both contact partners (pin/hole). Due to these cold welding processes intermetallic connections are generated leading to excellently low contact resistance values (commonly below 0.1mOhm / in sub-Milliohm range). Furthermore, the mechanical stability is significantly supported.

Press-fit pin and plated through hole (PTH) summarize together to a press-fit system. The functionality of such a system is dependent of the properties / characteristics of both of the components and their interactions (see also chapter 7).

## 2 | Overview press-fit solutions

The press-fit technology is widely applied in multiple automotive applications. Various customers are using press-fit technology in a great variety of convenient, assistance and safety applications demonstrating the high acceptance of TE's press-fit products and the press-fit termination technology itself.

Basically, TE's product portfolio could be distinguished into two major solution groups: press-fit contact terminals (for single pin insertion) and connector modules (for mass termination).

The press-fit terminals for single pin insertion commonly are supplied in a reeled condition allowing the customers to apply the contacts on their PCB's in a "free" and highly flexible manner.

Connector modules commonly feature highly customized housing components equipped with contacts (and other sub-components) in a potentially modular way according to the specific customer needs.

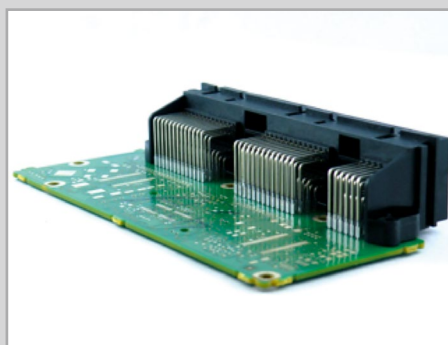
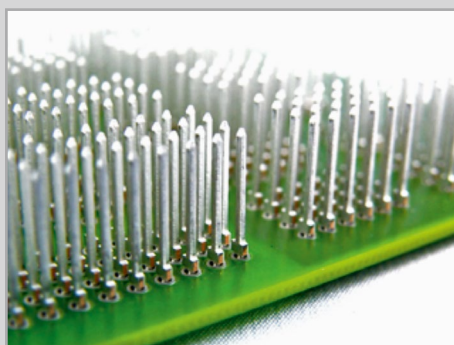

*Picture 2:  
Single pin insertion  
ACTION PIN inserted into a  
PCB (left) and mass termina-  
tion with a four row (>100  
press-fit pins) 900 header  
module (right).*

## 3 | Market Trends

The electronics in vehicles is between 2011 and 2016 expected to grow year over year. With that growing electronics intelligent bus systems replace simple cable connections and intelligent distribution boxes replace simple ignitions. Integrated information systems, computerized motor control management will enhance safety, performance and comfort. With more electronics also the amount of electrical connections in vehicles are continuously increasing.

In parallel there is a trend that vehicles are becoming smaller, safer, cheaper and better. New applications are mostly controlled by an electrical control unit (ECU) that needs to be as compact as possible. Inside each ECU there is a PCB carrying the electrical components that follows the same trend of miniaturization.

As a consequence of the electronification and miniaturization, more electrical interconnections are required on the same or even smaller packaging space. This drives the development to miniaturized interconnection components.

To meet this trend TE Connectivity has recently launched the miniaturized contact system NanoMQS product family for 0.4x0.5mm pins (see picture 3). In order to use less PCB space the pitch (distance between two contacts) for the NanoMQS contact system has been reduced from 2.54mm to 1.8mm in combination with a PTH size reduction from the standard 1.0mm to the 0.6mm type. Depending on the configuration it has been seen that this gives the opportunity to save up to 60% space compared to the standard MQS interconnection system using 0.63x0.63mm pins. There is also a trend to use the NanoMQS contacts together with press-fit technology and therefore TE Connectivity currently develops a new press-fit pin, the NanoMultispring.

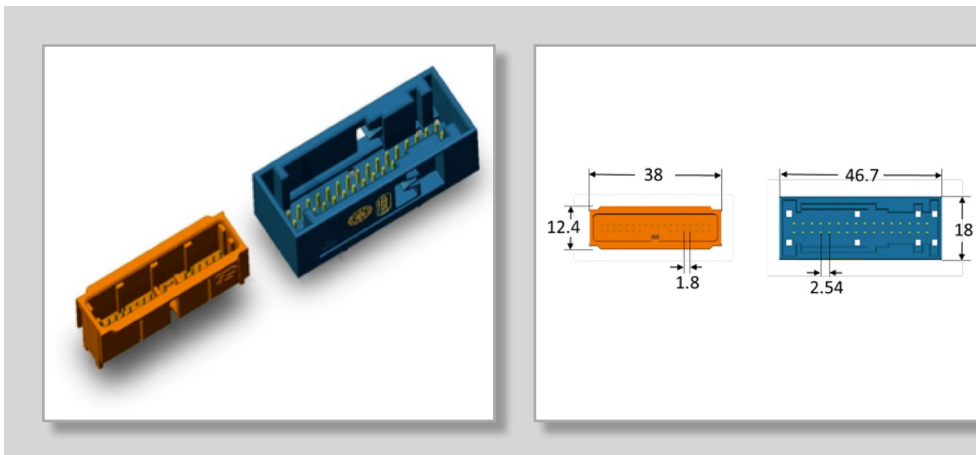

*Picture 3  
Showing space saving with  
NanoMQS vs MQS pin header  
interface.*

More demanding tougher environmental conditions and increased functional performance pushes the electrical interconnections including press-fit contacts to be more reliable. Also, with more electrical interconnections the requirements on each single component increase as the functionality over lifetime must be ensured for improved quality and reliability.

While today the most common PCB thickness in automotive applications is 1.6mm in future applications we may see thinner PCB's towards 1.2mm, 1.0mm or 0.8mm thicknesses. The press-fit solution needs as well to cope with this trend in addition to more demanding requirements.

The press-fit technology can offer many advantages that fit very well to the trends in the market and it can potentially be used in every contact-to-PCB interconnection.

## 4 | Materials

The press-fit pin can be made of different base materials featuring two galvanic layers, the under-plating and the top plating, in a sandwich structure. The picture 4 shows the most common materials and layers used in the automotive industry.

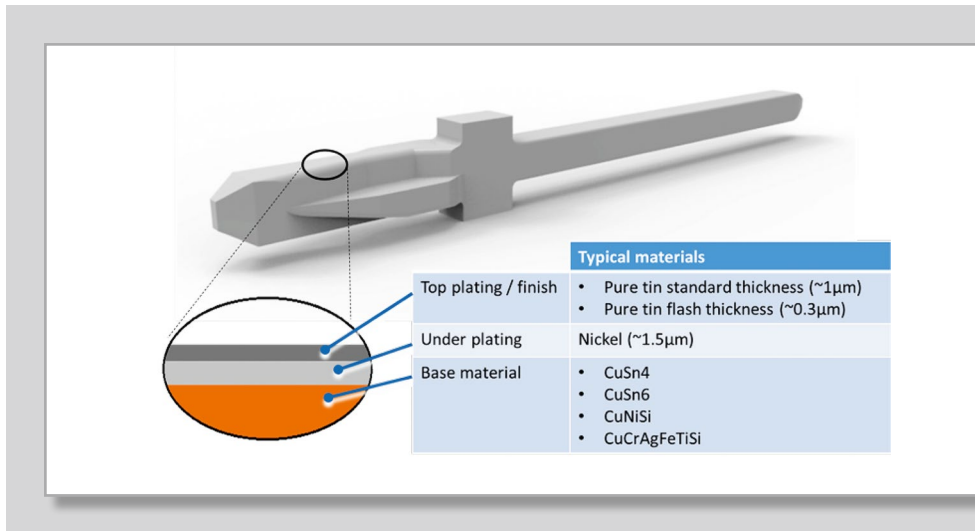

*Picture 4*  
The picture shows the typical materials used for press-fit pins.

## 5 | Comparison press-fit vs soldering

With the conversion to lead free soldering an increase of the average soldering temperature are required. To cope with this higher temperature, special and more expensive plastic materials like LCP, PPS, PPA and PCT are needed. This disadvantage can be avoided by using press-fit technology and discard the soldering process. In that way no expensive high temperature plastics are needed for a lead-free application. As space is an important factor in automotive applications the press-fit technology provides a solution which would be very difficult to realize with a conventional soldering process for miniaturization.

Especially the press-fit technology offers a solution for big connectors in combination with a reflow soldering process. In manufacturing electronic devices surface mounting technology (SMT) is a state of the art soldering process step applying numerous electronic components to a PCB. Large soldering headers often disturb the SMT reflow process. The pins of the header and neighboring components are obtaining a too low temperature, resulting in a defective soldering process. This can be solved by adding the header after the soldering process by means of press-fit technology.

The press-fit pin insertion process is fast, cheap and reliable manufacturing process that allows a repair of the press-fit pin up to two times. Another important aspect of press-fit technology is reliability. The press-fit connection is considered as one of the most reliable connection techniques. The reliability shown in the IEC1709 norm, shows that the press-fit connection has a fit-rate of 0.005 (see table 1), which is at least 10 times more reliable than soldering or IDC connections.

Type of connection	Details	Conductor cross-section mm <sup>2</sup>	Failure rate $\lambda_{ref}$ in FIT <sup>1)</sup>	Notes: Standards/Guide
Solder	manual machine		0.5 0.03	IPC 610 <sup>2)</sup> , class 2
Wire bond for hybrid circuits	Al Au		0.1 0.1	28µm / Wetch-Bond 25µm / Ball-Bond
Wire-wrap		0.05 - 0.5	0.002	DIN EN 60352-1 / IEC 60352-1 CORR1
Crimp	manual machine	0.05 - 300	0.25	DIN EN 60352-2 / IEC 60352-2 A 1+2
Termi-point		0.1 - 0.5	0.02	DIN 41611-4
Press-fit		0.3 - 2	0.005	IEC 60352-5
Insulation displacement		0.05 - 1	0.25	IEC 60352-3, IEC 60352-4
Screw		0.5 - 16	0.5	DIN EN 60999-1
Clamp	elastic force	0.5 - 16	0.5	DIN EN 60999-1

Failure rates for Electrical Connections

- 1) 1 FIT equals one failure in 10<sup>9</sup> component hours
- 2) Acceptability of Printed Board Assemblies

*Table 1  
Reliability table shows  
comparison between different  
electrical connection  
technologies.*

## 6 | Benefits with press-fit

Press-fit technology is a solder-less termination enabling a permanent electrical and mechanical terminal-to-PCB connection with several distinctive advantages:

- Fast processing → comparative data: lead time soldering vs. press-fit
- Use of standard resins instead of cost intensive heat stabilized resins in the header
- Prevents thermal treatment to the header
- Flexible application designs with single pin insertion due to freely programmable pin arrays in terms of pin numbers and orientation
- Stand-alone pin insertion possible
- Lubrication and flux aid free processing
- Prevents solder paste printing and pre-heating
- Environmental friendly
- No shading-off issues with large header components in post-soldering insertion
- Prevents soldering defects like bridges, bad wetting, flux residuals, solder balls, spider webs thermal load and cold solder joints

Of course, matching application equipment is needed to manufacture press-fit technology related modules (instead of soldering equipment). Since this is commonly highly flexible and automated the machinery equipment can be used for several different products and applications.



## 7 | Product characteristics and qualification

The overall press-fit product characteristic features several electrical and mechanical functions.

### FUNCTIONS

Functions = f (properties)

#### Electrical functions (desired in brackets)

- Contact resistance (low)
- Current carrying capacity (high)

#### Mechanical functions (desired)

- Insertion force (low)
- Retention force (high)
- Through hole deformation (low)

The practical performance in terms of these functions is depending on multiple properties mainly coming from the press-fit pin (and its type of application) and the PCB/PTH.

### PROPERTIES

#### Press-fit pin properties

- Design/Shape/Size
- Base material
- Plating (type & thickness)

#### Through hole properties

- Drill diameter
- Copper tube thickness
- Plating (type & thickness)
- Board material
- Pre-processing (reflow etc.)

In addition, the insertion process can contribute to the functional results (insertion depth, ins. Velocity).

The relation between properties and functions is highly interactive in that manner that certain singular properties may affect certain or even all functions up to certain degrees; with some of them being shifted counter-wise. Also, single functions can depend on multiple properties and their interactions.

Since it is generally not possible to change or shift single functions independently the overall performance is to be considered when discussing single properties. The interactive correlation can require a prioritizing of a major function. If so, this should be done in thorough respect of the application and final product needs.

## 8 | Application overview

Press-fit technology can be used in several application families. This is a short overview of the versatile possibilities to use it:

A stand-alone pin is the most basic method of using press-fit technology. The pins are inserted individually with a high frequency into the PCB, in general by means of automatic equipment. The contact terminal has a shoulder geometry which provides the necessary support to press-in the pin into the PCB. For stand-alone pins with 5 mm pitch insertion rates up to 5 pins per second can be reached with a P350 insertion machine from TE Connectivity. The insertion process can be controlled by measuring press-in force and/or depth to obtain an optimum connection and to support quality control measures. In most applications a shroud is added afterwards to guide the counter connector.

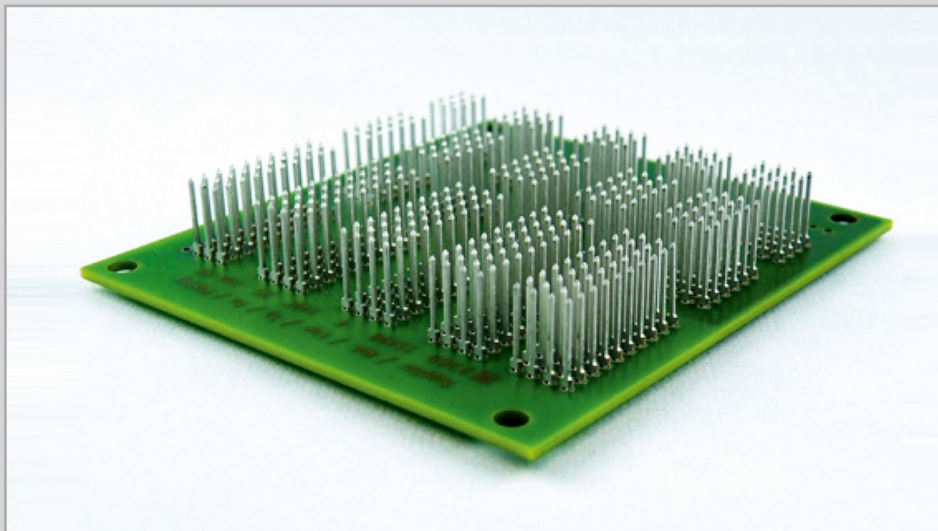

*Picture 5  
Stand-alone press-fit pins  
inserted into a PCB.*

One of the most common applications is the use of a press-fit pin header, which is an assembly of a plastic housing and contact terminals. Typically these pins are assembled using stitching or an over-molding process. The mating direction of the pin header can be parallel (90°), angled or perpendicular (0°) to the printed circuit board. Depending on the annual numbers needed, the pin header assembly is done with a manual, semi-automatic or automatic connector seating machine. The pin header is mounted onto the PCB by pressing on the shoulders of the press-fit pins. There are also applications where the mounting is done by pressing onto the plastic material of the pin header.

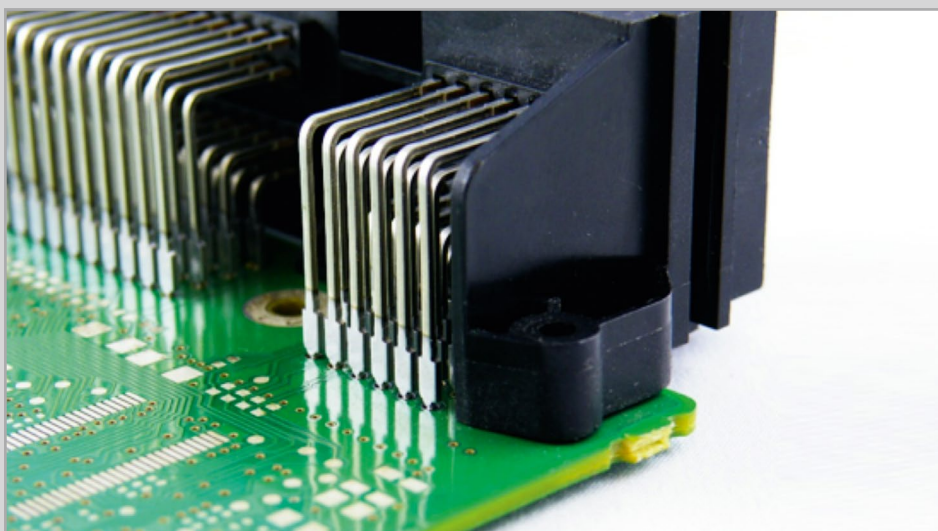

*Picture 6  
Pin Header 90° with press-fit  
pins inserted into the PCB.*

Another form of application which is quite common with press-fit technology is an integrated housing or module. Coils, capacitors, actuators and sensors are some examples of the possible elements which can be integrated in the same housing and sharing a single PCB. ABS/ESC housings, sensor housings, anti-theft antennae are some examples of using press-fit technology to make the assembly process of the application more easy and reliable. The mechatronics possibilities are endless.



*Picture 7*  
Examples of an ABS/ESC housing (left) and a theft antenna module (right) using press-fit technology.

Some of the applications are not possible to position into a standard category. An interconnection between two printed circuit boards, a capacitor using press-fit technology and an IDC flat cable connector are only a few solutions that can be realized.

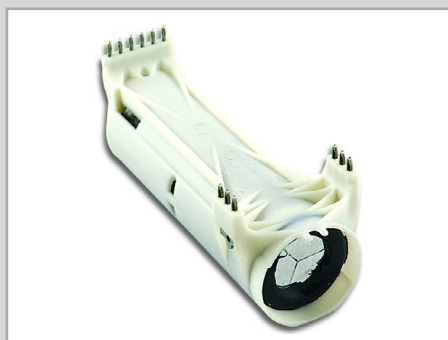
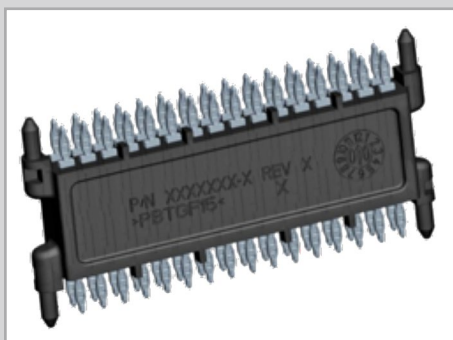

*Picture 8*  
Examples of a 32pos interconnection between two PCBs (left) and a capacitor holder (right).

## 9 | Application tooling

Besides press-fit contacts and modules TE designs, manufactures and offers the matching machinery equipment. Thus, customers can benefit from “one-hand supplier” advantages.

Single pin insertion machines for highly flexible seating conditions as well as connector (module) seating machines are available perfectly fitting to TE’s product portfolio and readily set-up for the specific customer needs and production line integration.

### Single pin insertion machines

For the insertion of single pins into PCBs TE Connectivity offers a complete portfolio covering all production needs. A manual arbor press P10 for the insertion of loose piece pins as repair station or for sample production. A manual operated bench machine P50 (see Picture 9) with manual PCB positioning but automatic pin insertion. The P50 uses the same terminal specific, easy to change conversion kits as the rest of the machines in the portfolio. The P100 is a manually loaded insertion machine with programmable positioning of the PCBs and automatic pin insertion.



Picture 9  
Pin insertion machine P50.

All tools and machines can be equipped with insertion force monitoring to fulfill the quality requirements of automotive industry.

The flagships of the product line are the P300 and the P350 (see Picture 10). The P300 and the P350 are fully automatic Single Pin Insertion Machines and come with a substantial accessory range, enabling diverse requirements in modern production to be met and impressive performance data to be achieved. The insertion rate is 3.5 terminals per second in a 5.08 mm pitch for the P300, and 5 terminals per second for the P350. Quality and flexibility are the driving forces behind this machine. The flexibility of the insertion machine is ensured by using a maximum of four basic tools in the machine. Each of these basic tools comes with a product-specific conversion kit and can be changed within a few minutes from one product to the next. One advantage of these tools is that they enable the user to rotate the terminals. Instead of turning the PCB on a turntable, the insertion head of the TE Connectivity insertion machine turns the terminal.



Picture 10  
Pin insertion machine P350.

The accessory program includes:

- Image processing system to determine the position of the PCB and correct the insertion program
- PCB transfer conveyors for the integration into automated production lines, SMEMA compatible
- PCB thickness measurement at the beginning of the conveyor belt to compensate for thickness tolerances
- Tool changer for up to four insertion tools
- Tool changer for up to four support tools
- Twin feed conversion kit to feed two terminal strips of the same base dimension on one base tool
- Pin protrusion measuring system to determine pin tip to PCB surface distance
- Monitoring and documentation of the applied force
- Advanced Software process data capture and traceability
- Motor-driven insertion tool for continuous wire with enhanced accuracy
- Freely programmable rotating insertion finger
- Rotary support tool
- Force-distance curve determination even at high speeds
- Pin length measuring in the Insertion Tool

More details and technical features about application tooling can be found on [www.te.com](http://www.te.com).

## Connector seating machines

To assemble press fit connectors onto PCBs or to press PCBs into housings with over-molded press-fit pins TE Connectivity offers a complete portfolio covering all production needs. The servo driven all electric presses with a force range between 44 kN and 115 kN have been used in EMS industry for more than 20 years and have been proven to be very reliable and accurate. All presses come with force distance monitoring as a standard feature.

For the applications in automotive industry the presses can be equipped with Pin Presence Detection, automatic positioning of tooling under the press ram and programmable positioning of the press ram. In addition automatic connector loading out of tubes or trays is available as well. Connections to state of the art or customized traceability systems allow the integration of the Connector Seating Machines into today's production environment.

## Manufacturing quality/capability: press-fit vs. soldering

With single inserted press-fit pins the insertion force monitored provides a quality statement for each inserted component. The equivalent for connectors is the force-distance monitoring on TE servo-electric press lines with machines designed to fulfill all production requirements.

## 10 | Future / New developments

To meet the future trends for smaller pitch and smaller packaging space a new miniaturized press-fit pin will be needed. Therefore TE Connectivity is currently developing the NanoMultispring press-fit pin (see Picture 11). The NanoMultispring pin is made from 0.4mm stock (material) thickness. It is based on the same press-fit zone as the larger versions, the Multispring standard pin made from 0.6mm stock thickness and the Multispring standard power pin made from 0.8mm stock thickness, which was developed and introduced in the automotive industry in the early 90ies. In first step the NanoMultispring contact will be developed for PCB end hole diameter 0.6mm and will meet the requirements in the IEC 60352-5.

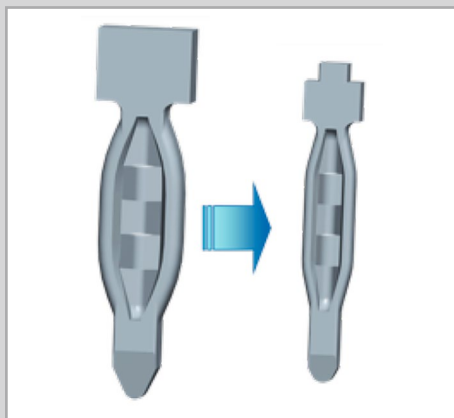

*Picture 11  
Standard Multispring and  
NanoMultispring pin.*

Historically the press-fit pins from TE Connectivity were developed for Hot Air Leveled (HAL) tin-lead PCBs. Due to that the RoHS (Restriction of the use of certain hazardous substances in electrical and electronic equipment) directive took effect in July 2006 the automotive industry needed to change to lead-free products. Therefore, the immersion tin PCB became the most common PCB technology used in the automotive industry. Shifting from tin-lead to pure tin plating's effected the Press-in behavior mainly in terms of mechanical performance (insertion- and retention forces and through hole deformations) and increased risk of tin whiskers. While the insertion and retention forces are basically an effect of the changed frictional behavior the risk of tin whiskers is a metallurgical effect.

Tin whiskers are small hair-like single crystalline filaments that can grow due to strain gradients in metal materials. Tin whiskers are conductive and can cause bridging between two electrical components. There is at the moment, for applications featuring pure tin plated components, no clear solution how to cope with the tin whiskers risk. The trends are going in different directions with different materials and plating's. As tin whiskers potentially can cause shortcut between electrical contacts it is important to find new whisker-reducing and ultimately whisker-free plating solutions. Whisker mitigation can be supported by adding lead (Pb) to the tin (Sn) plating though this solution is not preferred as it is likely that lead in the future will also be prohibited for press-fit products.

TE can offer tin flash plating as a tin whiskers mitigation solution. Tin flash plating is thinner than traditional tin plating solutions with a plating thickness of typical 0.3µm. The thinner plating significantly reduces the tin whiskers risk in terms of frequency and maximum length.

TE Connectivity is also currently developing the whisker-reducing plating, AgenTin, which is a combination of silver and tin layer finishes. The AgenTin plating will be possible to use in combination with both the ACTION PIN and the Multispring press-fit pins and tests show promising results. In terms of needs for technical support TE Connectivity is available for discussions, assessment and expertise.

In addition to the pin plating the PCB plating technologies affect the tin whisker results and the overall press-fit system performance. Other PCB plating technologies used in addition to Immersion tin are Immersion Silver and Immersion Gold. Furthermore a future trend could be to use copper + OSP (Organic Solderable Preservative) coated PCBs. It is important that the future press-fit pin plating technologies and the PCB technologies together can meet the requirements of the system.

TE Connectivity is currently developing a new plating solution which does not support any whisker built with the goal using environmental friendly and in the future available materials.

## 11 | Legal Details

© 2014 TE Connectivity family of companies. All rights reserved.

EVERY CONNECTION COUNTS, TE, TE Connectivity, TE connectivity (logo), ACTION PIN, AgenTin, MQS, NanoMQS, Multispring, and NanoMultispring are trademarks.

Siemens is a trademark. Other logos, product and Company names mentioned herein may be trademarks of their respective owners.

While TE Connectivity (TE) has made every reasonable effort to ensure the accuracy of the information in this whitepaper, TE does not guarantee that it is error-free, nor does TE make any other representation, warranty or guarantee that the information is accurate, correct, reliable or current. TE reserves the right to make any adjustments to the information contained herein at any time without notice.

TE expressly disclaims all implied warranties regarding the information contained herein, including, but not limited to, any implied warranties of merchantability or fitness for a particular purpose. The dimensions in this whitepaper are for reference purposes only and are subject to change without notice. Specifications are subject to change without notice. Consult TE for the latest dimensions and design specifications.